

OMNI

PLATING SYSTEM
Surgical Technique

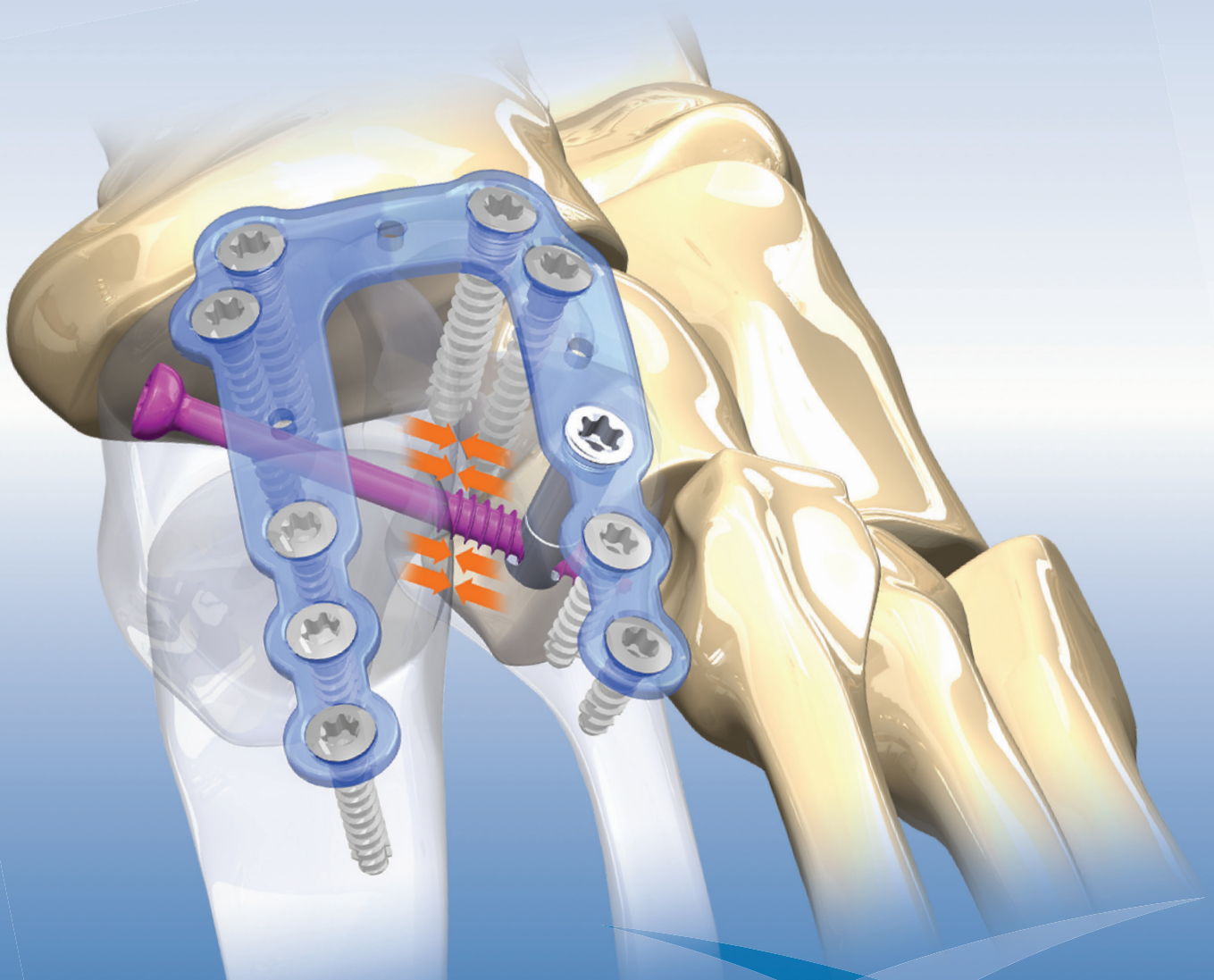

EXTREMITY[®]
MEDICAL

Customer Service: 888.499.0079
www.extremitymedical.com

INDICATIONS FOR USE

The Omni Plating System is intended for use in internal fixation of arthrodeses, osteotomies, fractures and nonunions of the small bones of the foot & ankle including the fore-, mid-, and hind foot and ankle applications.

The Omni Plating System is a universal plating system that accommodates many foot and ankle indications. The Omni Plating System's plate screws are available in 2.8mm & 3.5mm non-locking and variable angle locking options (30° cone of angulation). The novel PlantarFiX™ Post provides the surgeon a unique option designed to work with the 3.5mm Cannulated Compression Screw to generate consistent plantar-side compression, regardless of patient bone quality. The PlantarFiX Post is compatible with the locking holes of all the plates in this system. The unique instrumentation of the Omni Plating System facilitates the accurate delivery of the Cannulated Compression Screw into the PlantarFiX Post.

OMNI Plating Options

MTP Fusion



- Left & Right
- Narrow
- Standard, Long, and Dorsiflexed

Lapidus



- 5 Hole, Left
- 5 Hole, Right

Lisfranc

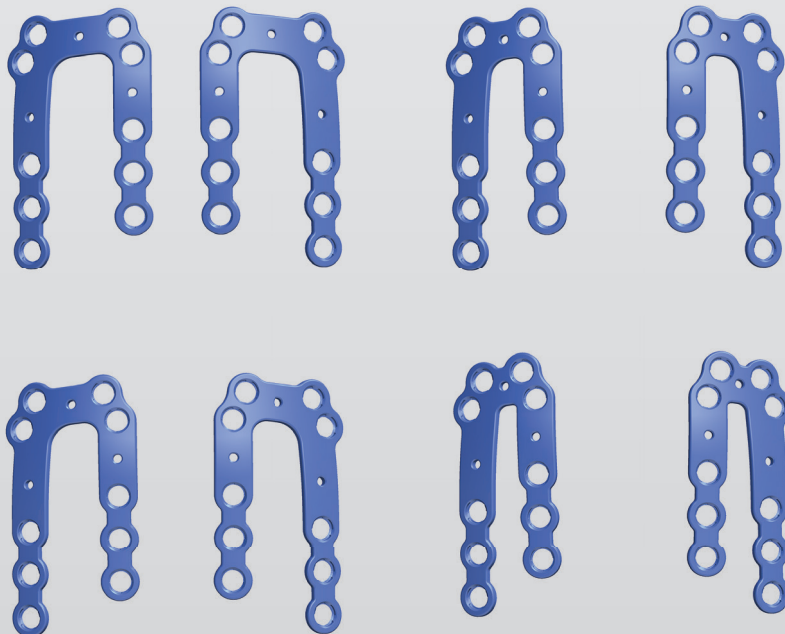

- Large: Left & Right
- Medium: Left & Right
- Small: Left & Right
- Extra Small: Left & Right

X-Plate



- Left
- Right



Dogbone



- Short
- Long



T-plate



• T-Plate, 5 Hole (Universal)



• T-Plate, 6 Hole (Universal)

• T-Plate, 4 Hole, Left & Right

• T-Plate, 5 Hole, Left & Right



Straight plates



• 2 Hole



• 4 Hole

• 5 Hole

• 6 Hole

• 7 Hole

• 8 Hole



Screw Types



2.8mm Non-locking Screw



2.8mm Locking Screw

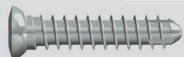

3.5mm Non-locking Screw

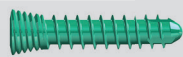

3.5mm Locking Screw

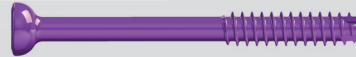

3.5mm Cannulated Compression Screw

Variable Angle Locking



30° Degree Cone of Angulation

PlantarFiX™ Post



12 & 16mm Lengths

PlantarFiX Post Technology

The PlantarFiX Post can be used in any of the locking holes in all of the plates of the Omni Plating System. This patent pending technology allows the surgeon to place a 3.5mm compression screw through the PlantarFiX Post. This Post acts a metal cortex and ensures consistent compression across the joint. The following technique offers general instrumentation guidance along with representations of the preferred placement location of the PlantarFiX Post for various common indications.



Omni Joint Preparation Instruments

MTP Cup and Cone Rasps
(14-20mm)

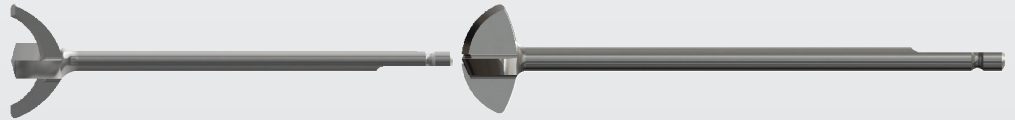

MTP Barrel Reamer

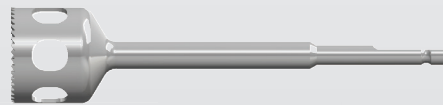

General Joint Preparation Rasp



Fenestrating Drill



Hintermann Compressor/Distractor

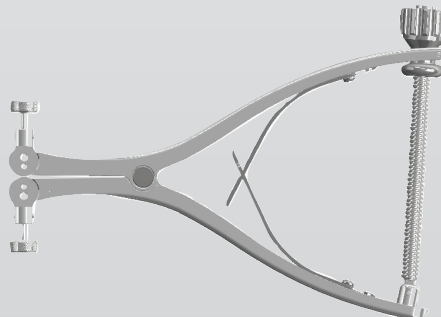

General Instruments

Non-Locking Drill Guides

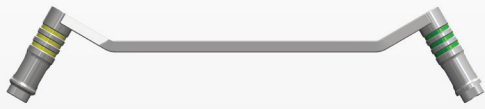

Locking Drill Guides

2.8mm 3.5mm

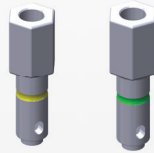

Olive Wires

1.6mm



Smooth Tip, Short

Threaded Tip, Long

Smooth Tip, Long

Drivers



T10 Solid



T15 Cannulated

PlantarFiX Post Instruments

Post Drill Guide

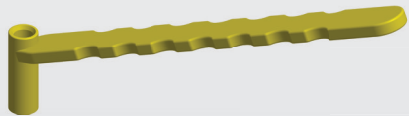

Post Drill



Post Adjuster



Targeting Guide



Wire Guide



2.5mm Drill Sleeves

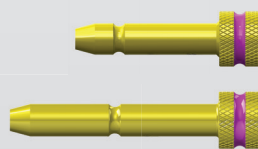

2.5mm Drill with stop

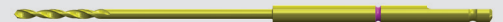

Cannulated Depth Gauge

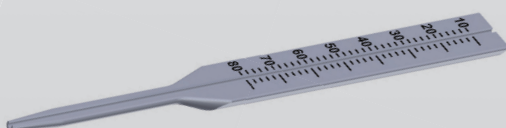

General Instruments/Technique

Placement of Plate Screws:

The Drill Sleeves should be used for all locking and non-locking screws placed within standard plate holes. Omni plate holes allow screws to be placed within a 30° cone of angulation. Thread the Drill Sleeves into the plate at the desired angle (within the 30° cone). Drill for the screws with the appropriate size solid drill through the dedicated Drill Guide. Measure screw length with the AO-style Depth Gauge. Place the selected screw with the T10 Driver.

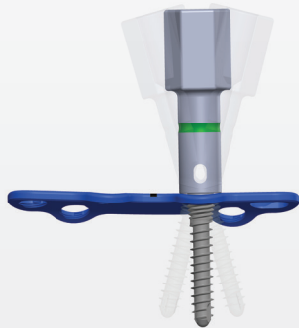

Screw Size	Drills	Drill Guide & (color code)	Driver Size
2.8mm (lock/non-locking)	2.0mm (solid)	Yellow ●	T10
3.5mm (lock/non-locking)	2.7mm (solid)	Green ●	T10
3.5mm Compression Screw	2.5mm (cannulated)	Magenta ●	T15

Placement of Non-locking Screws in compression slots:

Utilize the Non-locking Drill Guides for all non-locking screws placed in a compression slot.

Compression Screw

Place the Compression Drill Guide into the compression slot of the plate with the handle away from the plate. This will create an eccentric hole allowing for compression.

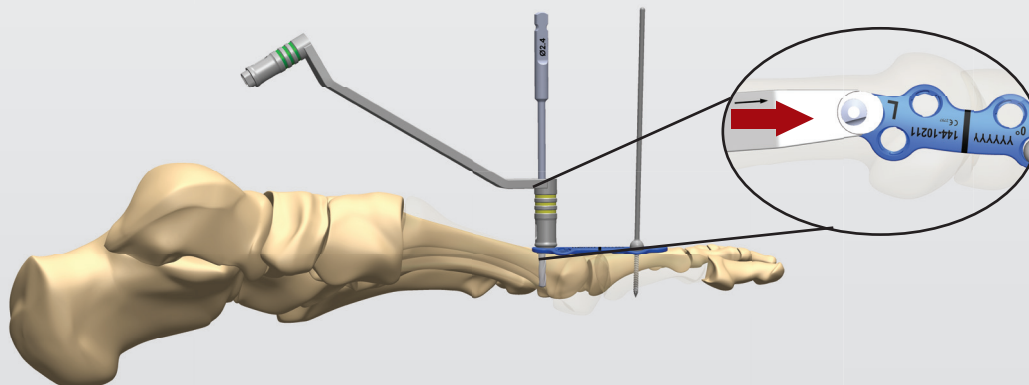

Neutral Non-locking Screw

To place a neutral (non-compression) screw in a slot, the Non-Locking Drill Guide should be oriented with the handle over the plate.

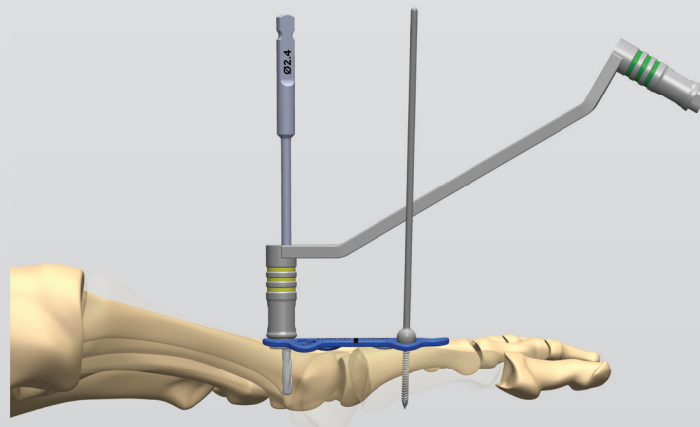

Technique Guidelines for PlantarFiX Post and Compression Screw Placement

Prepare the articular surface of the joint utilizing the distraction device, joint preparation rasps, and fenestrating drill as desired. Align and provisionally pin the joint with a 1.4mm Guidewire to maintain reduction. Place the Omni plate in the desired position and pin the plate to bone with Olive Wires.

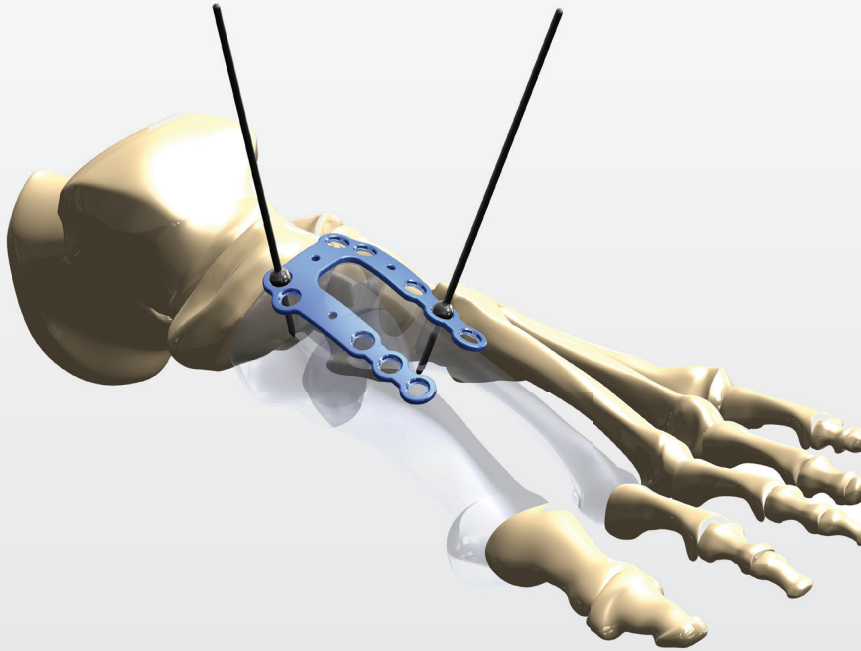

To generate compression with the PlantarFiX Post and 3.5mm Compression Screw, first decide in which locking hole the Post will be placed. Place screw fixation in the holes on the same side of the plate as the Post. This secures the plate to bone and allows for the full effect of the compression when the Post/Compression Screw is applied.

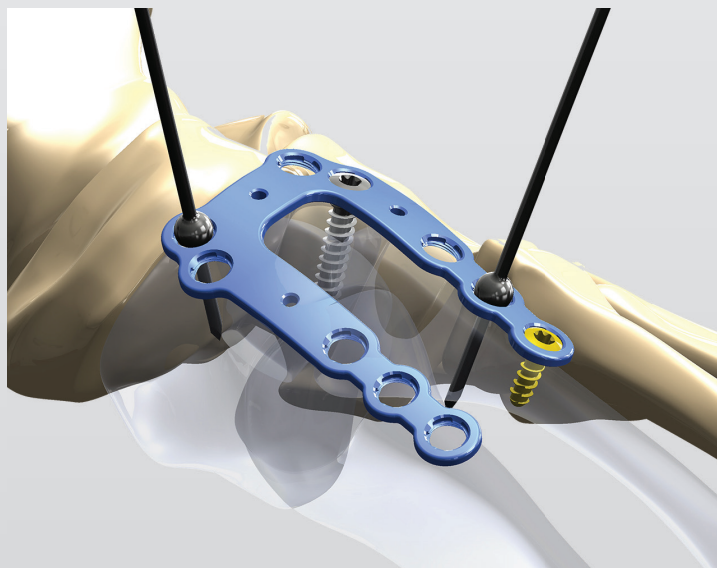

PlantarFiX Post and Compression Screw Placement Guidelines

Place the Post Drill Guide in the desired hole of the Plate. Drill with the Post Drill to the desired depth. Measure the length of the PlantarFiX Post off of the calibration on the Post Drill/Post Drill Guide. The PlantarFiX Posts are available in 12 and 16mm lengths.

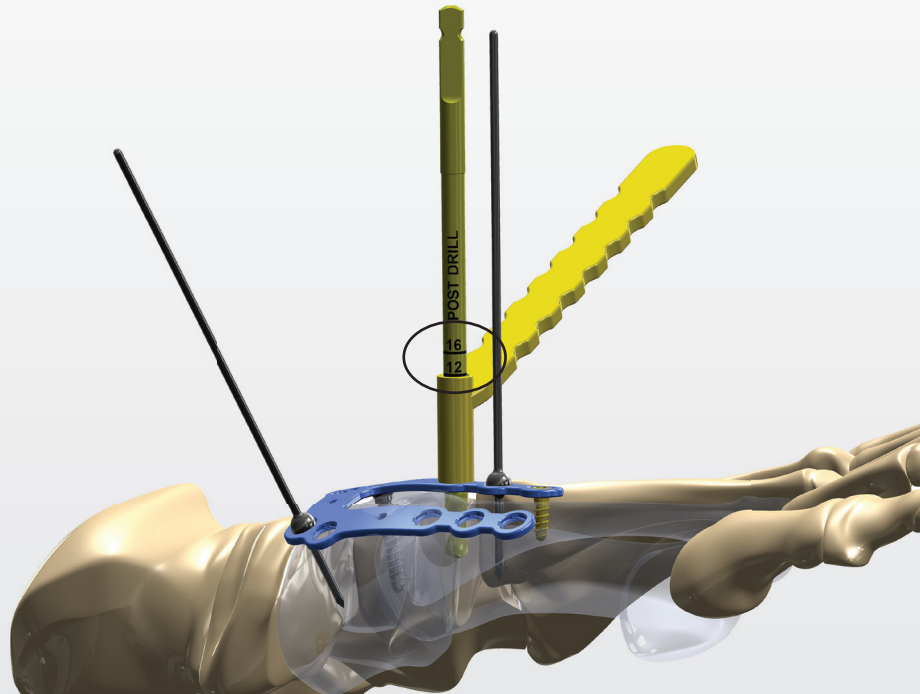

Insert and lock the PlantarFiX Post into the plate with the T15 Driver. The proximal end of the Post locks into the plate in the same manner as the locking screws.

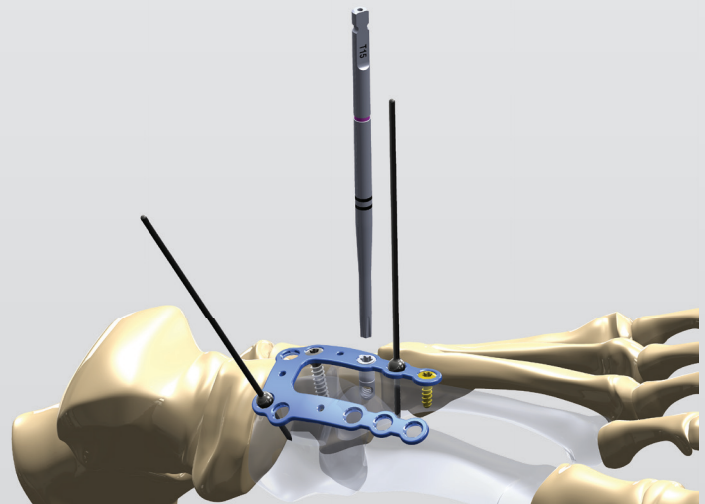
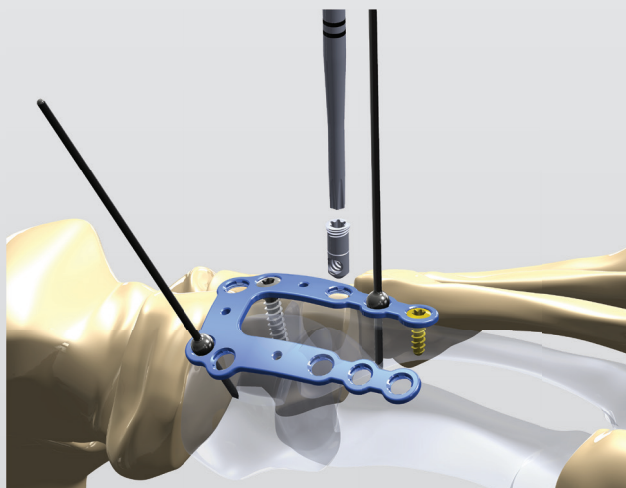

The plantar-side hole of the PlantarFiX Post rotates 360° to allow for flexible screw placement. Place the Post Adjuster into the head of the Post. Rotate the Post Adjuster until the black laser line is oriented towards the desired trajectory for the 3.5mm Cannulated Compression Screw. This will rotate the plantar-side hole of the Post into position for the Targeting Guide.

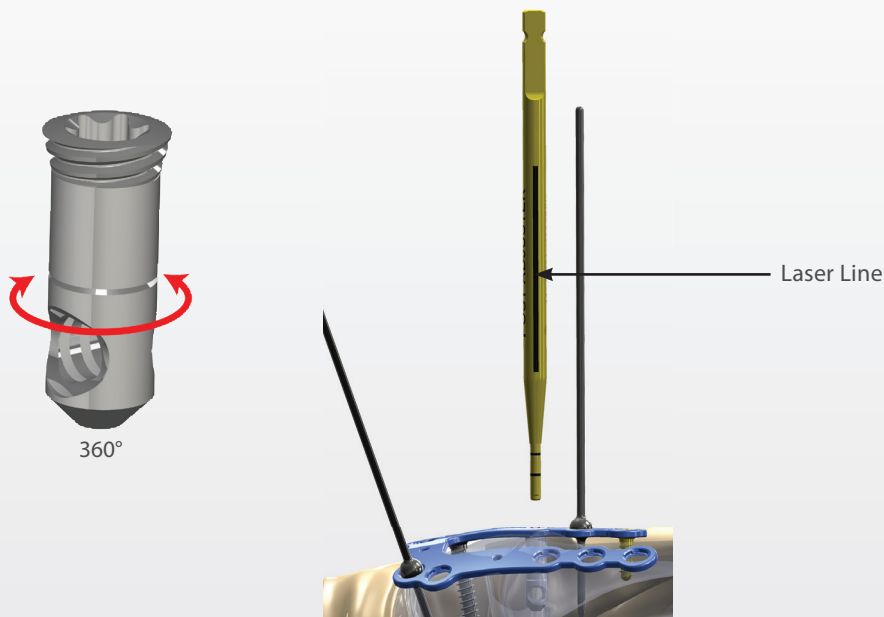

The Targeting Guide is keyed with the PlantarFiX Post which couples the distal hole of the Post with the Targeting Guide. Place the Targeting Guide into the Post.

Ensure that one of the laser marks on the Targeting Guide is in-line with the top of the Post:

- 16mm Post= top line
- 12mm Post= bottom line

Rotate the Guide to the desired position for the Compression Screw placement.

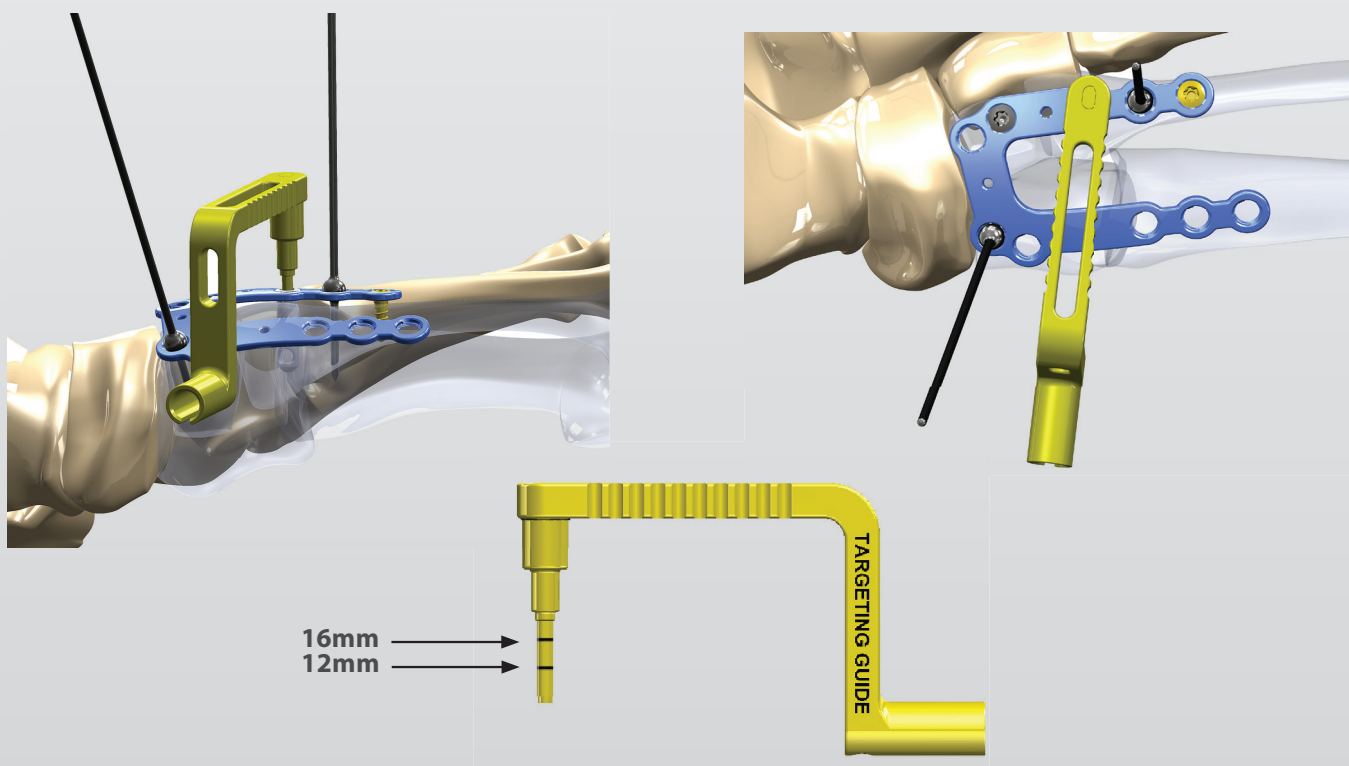

Drill to create the desired trajectory for the 3.5mm Compression Screw:

Place the 2.5mm Drill Sleeve (gold guide with magenta marking) into the Targeting Guide. Drill with the 2.5mm Solid Drill (gold with positive stop on shaft). Advance the 2.5mm Solid Drill until the depth stop on the drill reaches the Drill Guide's barrel.

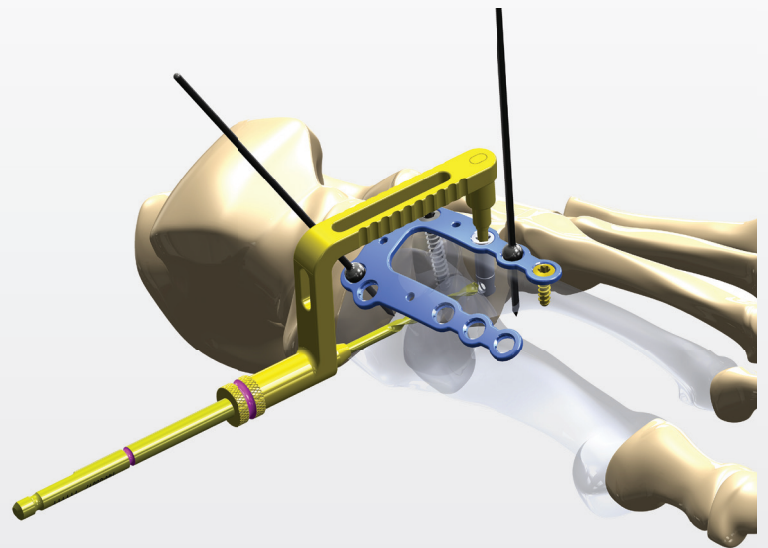
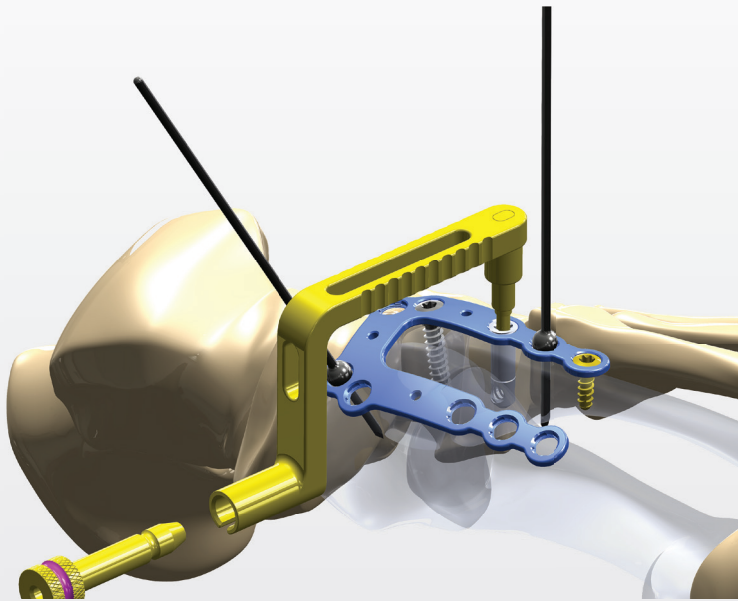

Thread the Wire Guide into the 2.5mm Drill Sleeve and advance a 1.4mm Guidewire through the PlantarFiX Post approximately 5mm past the Post. Confirm Guidewire positioning and placement with fluoroscopy.

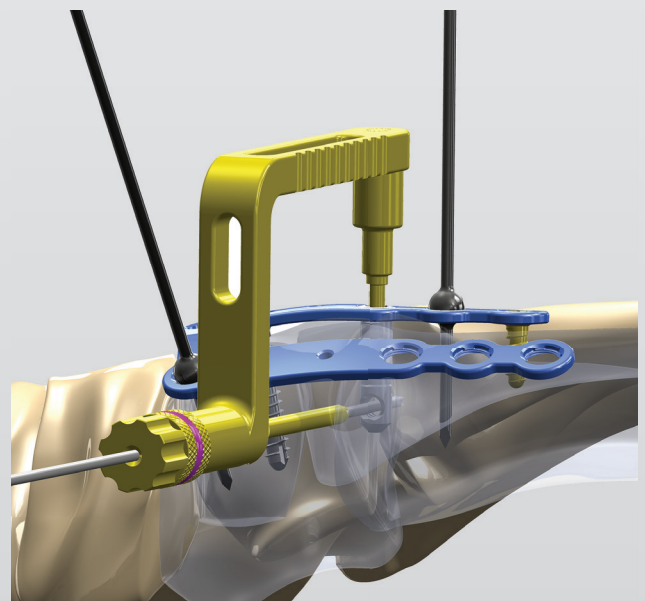
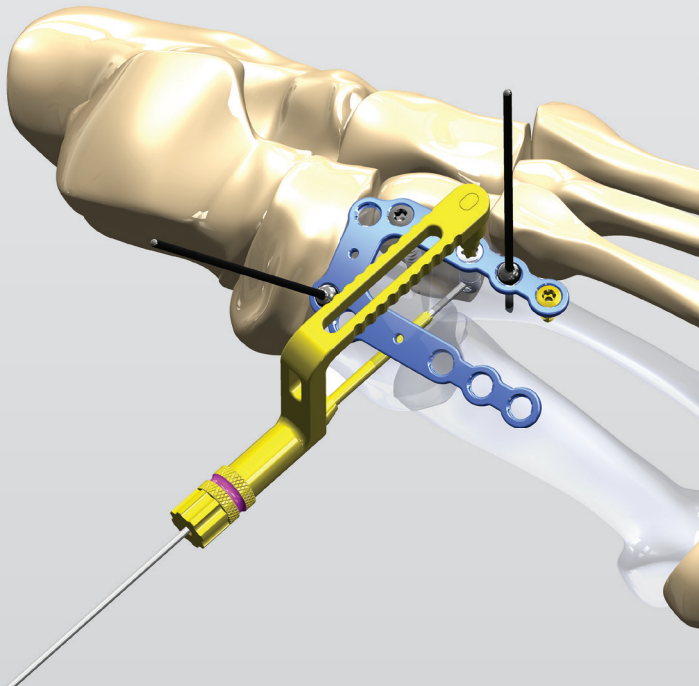

Remove the Drill Sleeve and Wire Guide. Advance the Cannulated Depth Gauge over the Guidewire and through the Targeting Guide down to bone to measure for the length of the 3.5mm Compression Screw.

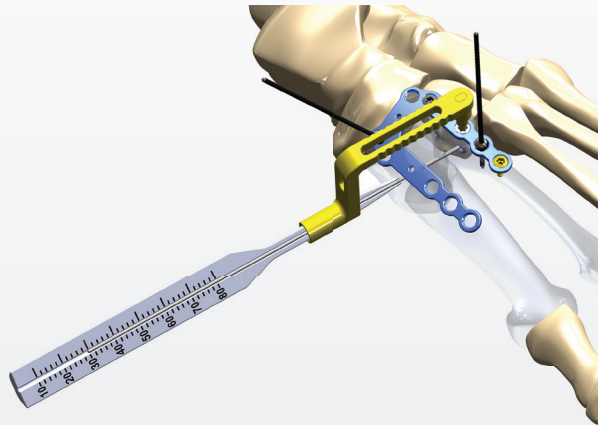

Insert the Compression Screw over the Guidewire (T15 Driver) until compression is achieved. The screw can be placed through the Targeting Guide as depicted, or the Targeting Guide can be removed.

NOTE: A cannulated Headed Screw Countersink is provided in the system. Countersinking is left up to the surgeon's discretion.

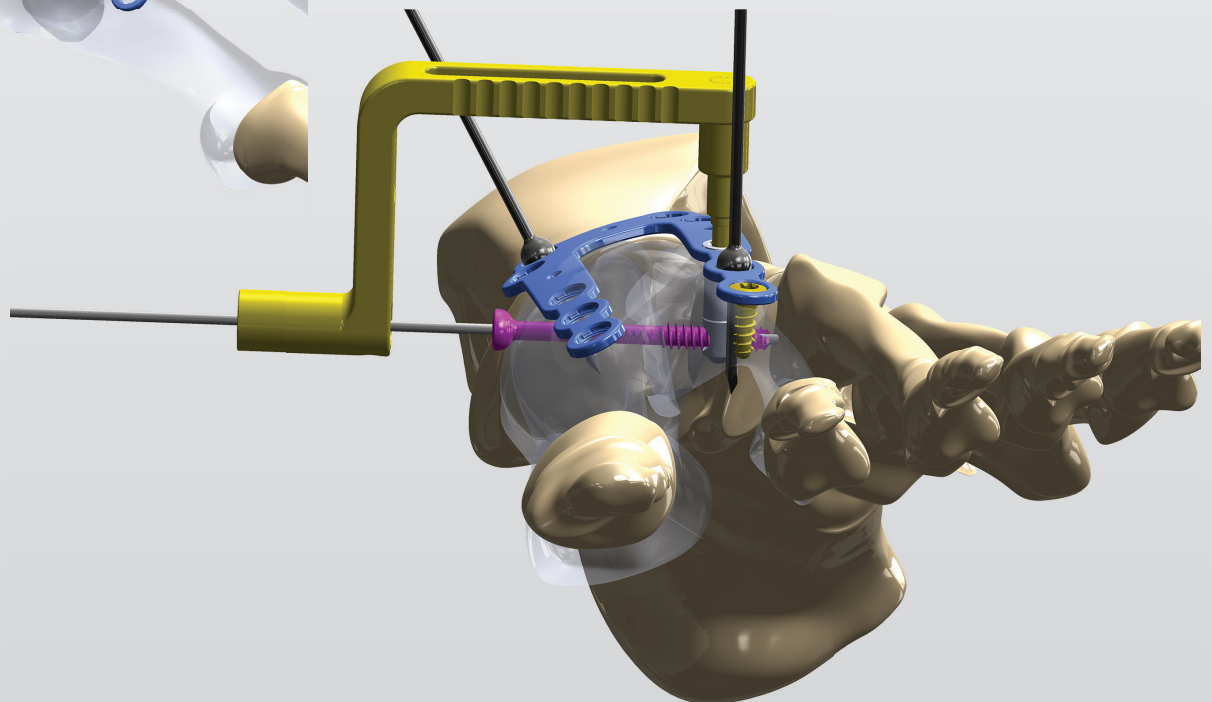
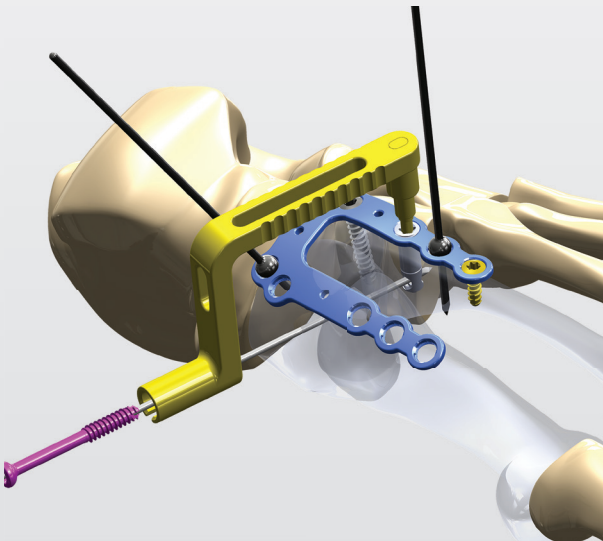

Insert 2.8mm or 3.5mm Screws (locking or non-locking) as desired in the balance of the plate holes.

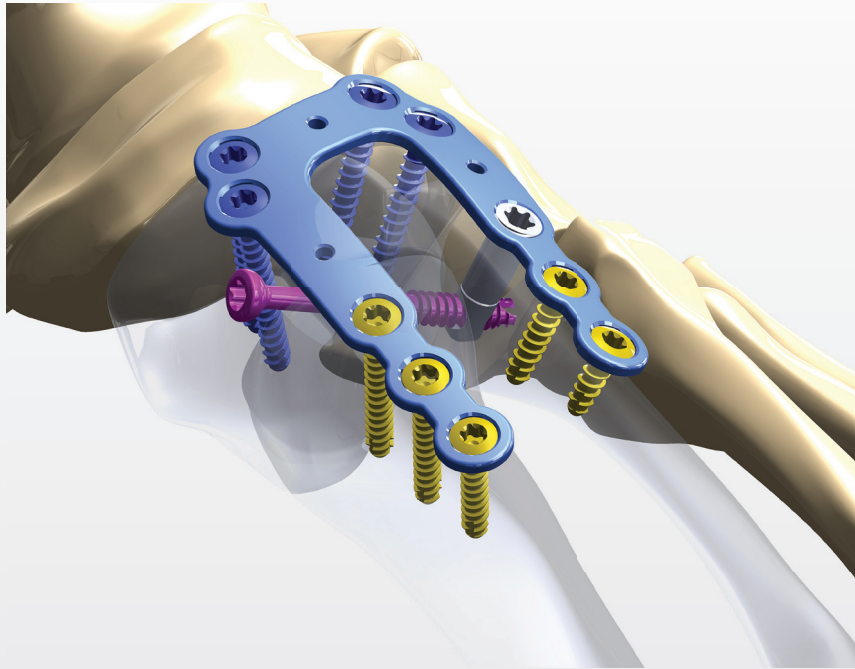

Alternative Post Placement Options for Lisfranc

The PlantarFiX Post can be used in all locking holes in any of the plates of the Omni Plating System.

Placement of the Post is left to the surgeon's discretion.

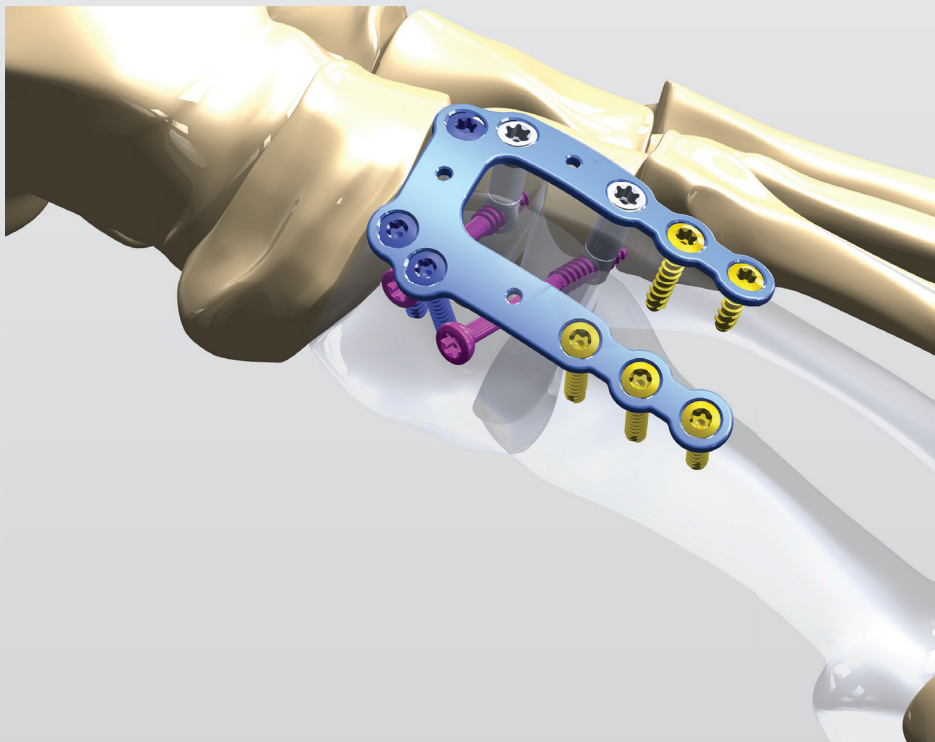

Lapidus

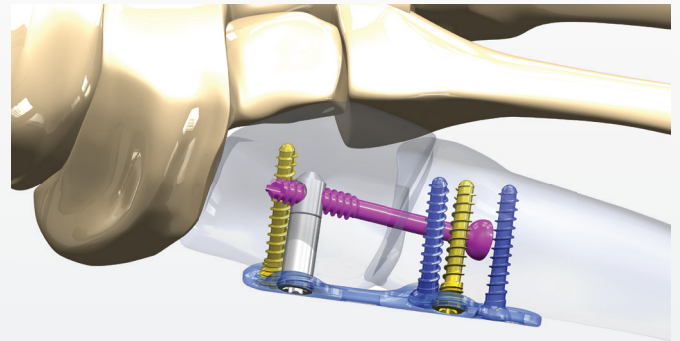
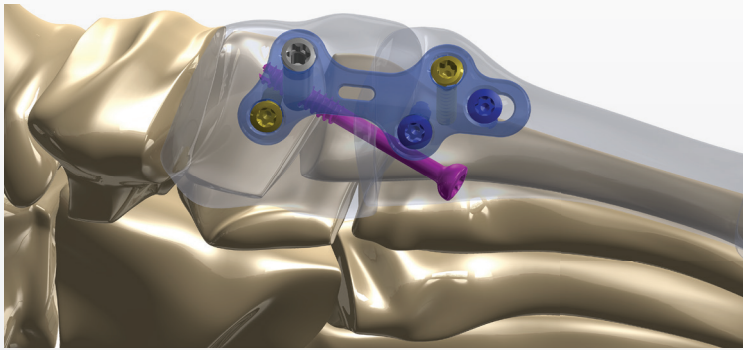

Talonavicular Fusion

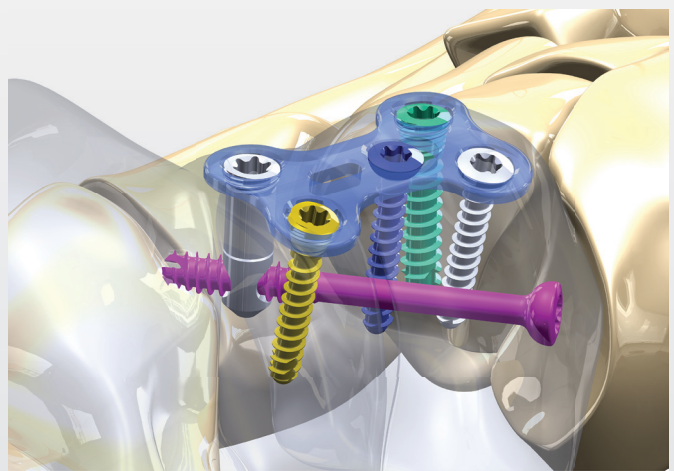
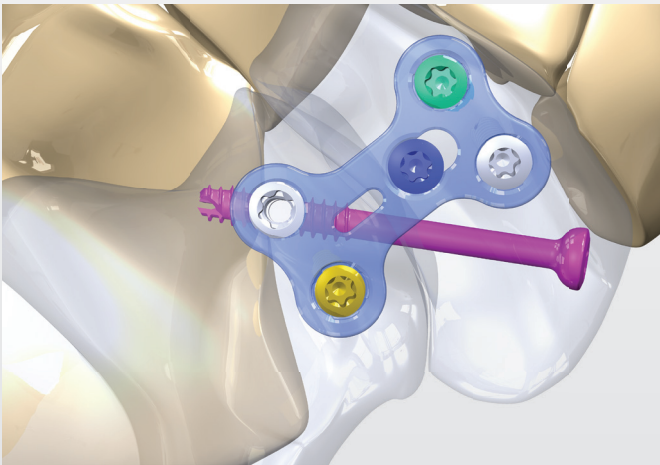

MTP Fusion

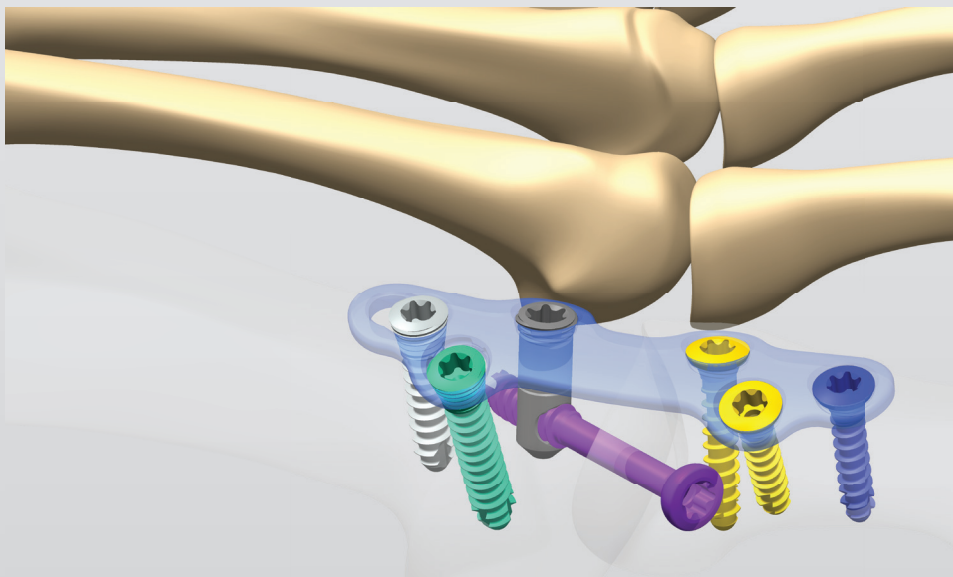

Removal Instructions

- Clear tissue in-growth from the screws
- Insert the T10 Driver into the screw head and remove the screw from the plate by turning the Driver counter-clockwise
- Remove all screws and then the plate
- If the PlantarFiX Post and 3.5mm Compression Screw is present, remove the 3.5mm Cannulated Compression Screw and then the subsequent PlantarFiX Post from the plate with the T15 Cannulated Driver prior to removing the screws in the plate

Plates

MTP Plates

Part #	Description
144-10211	MTP Fusion Plate (Narrow), Left
144-10212	MTP Fusion Plate (Narrow), Right
144-10241	MTP Fusion Plate (Narrow), Long, Left
144-10242	MTP Fusion Plate (Narrow), Long, Right
144-10251	MTP Fusion Plate (Narrow), Dorsiflexed, Left
144-10252	MTP Fusion Plate (Narrow), Dorsiflexed, Right

Lisfranc Plates

Part #	Description
144-80011	Lisfranc Plate, Extra Small, Left
144-80012	Lisfranc Plate, Extra Small, Right
144-80021	Lisfranc Plate, Small, Left
144-80022	Lisfranc Plate, Small, Right
144-80031	Lisfranc Plate, Medium, Left
144-80032	Lisfranc Plate, Medium, Right
144-80041	Lisfranc Plate, Large, Left
144-80042	Lisfranc Plate, Large, Right

Lapidus Plates

Part #	Description
144-70051	Lapidus Plate, 5 Hole, Left
144-70052	Lapidus Plate, 5 Hole, Right

X-Plates

Part #	Description
144-30011	X-Plate, Short, Left
144-30012	X-Plate, Short, Right

Dogbone Plates

Part #	Description
144-40011	Dog Bone Plate, Narrow, Short
144-40012	Dog Bone Plate, Narrow, Long

T-Plates

Part #	Description
144-50050	T-Plate, 5 Hole (Universal)
144-50060	T-Plate, 6 Hole (Universal)
144-60041	T-Plate, 4 Hole, Left
144-60042	T-Plate, 4 Hole, Right
144-60051	T-Plate, 5 Hole, Left
144-60052	T-Plate, 5 Hole, Right

Straight Plates

Part #	Description
144-20020	Straight Plate, 2 Hole
144-20040	Straight Plate, 4 Hole
144-20050	Straight Plate, 5 Hole
144-20060	Straight Plate, 6 Hole
144-20070	Straight Plate, 7 Hole
144-20080	Straight Plate, 8 Hole

Screws

2.8mm Solid Non-Locking Screws

Part #	Description
144-28010	Solid Non-Locking Screw - 2.8 x 10mm
144-28012	Solid Non-Locking Screw - 2.8 x 12mm
144-28014	Solid Non-Locking Screw - 2.8 x 14mm
144-28016	Solid Non-Locking Screw - 2.8 x 16mm
144-28018	Solid Non-Locking Screw - 2.8 x 18mm
144-28020	Solid Non-Locking Screw - 2.8 x 20mm
144-28022	Solid Non-Locking Screw - 2.8 x 22mm
144-28024	Solid Non-Locking Screw - 2.8 x 24mm
144-28026	Solid Non-Locking Screw - 2.8 x 26mm
144-28028	Solid Non-Locking Screw - 2.8 x 28mm
144-28030	Solid Non-Locking Screw - 2.8 x 30mm

2.8 mm Solid Locking Screws

Part #	Description
144-28110	Solid Locking Screw - 2.8 x 10mm
144-28112	Solid Locking Screw - 2.8 x 12mm
144-28114	Solid Locking Screw - 2.8 x 14mm
144-28116	Solid Locking Screw - 2.8 x 16mm
144-28118	Solid Locking Screw - 2.8 x 18mm
144-28120	Solid Locking Screw - 2.8 x 20mm
144-28122	Solid Locking Screw - 2.8 x 22mm
144-28124	Solid Locking Screw - 2.8 x 24mm
144-28126	Solid Locking Screw - 2.8 x 26mm
144-28128	Solid Locking Screw - 2.8 x 28mm
144-28130	Solid Locking Screw - 2.8 x 30mm

PlantarFiX Posts

Part #	Description
144-42112	PlantarFiX Post - 12mm
144-42116	PlantarFiX Post - 16mm

3.5mm Solid Non-Locking Screws

Part #	Description
144-35010	Solid Non-Locking Screw - 3.5 x 10mm
144-35012	Solid Non-Locking Screw - 3.5 x 12mm
144-35014	Solid Non-Locking Screw - 3.5 x 14mm
144-35016	Solid Non-Locking Screw - 3.5 x 16mm
144-35018	Solid Non-Locking Screw - 3.5 x 18mm
144-35020	Solid Non-Locking Screw - 3.5 x 20mm
144-35022	Solid Non-Locking Screw - 3.5 x 22mm
144-35024	Solid Non-Locking Screw - 3.5 x 24mm
144-35026	Solid Non-Locking Screw - 3.5 x 26mm
144-35028	Solid Non-Locking Screw - 3.5 x 28mm
144-35030	Solid Non-Locking Screw - 3.5 x 30mm

3.5mm Solid Locking Screws

Part #	Description
144-35110	Solid Locking Screw - 3.5 x 10mm
144-35112	Solid Locking Screw - 3.5 x 12mm
144-35114	Solid Locking Screw - 3.5 x 14mm
144-35116	Solid Locking Screw - 3.5 x 16mm
144-35118	Solid Locking Screw - 3.5 x 18mm
144-35120	Solid Locking Screw - 3.5 x 20mm
144-35122	Solid Locking Screw - 3.5 x 22mm
144-35124	Solid Locking Screw - 3.5 x 24mm
144-35126	Solid Locking Screw - 3.5 x 26mm
144-35128	Solid Locking Screw - 3.5 x 28mm
144-35130	Solid Locking Screw - 3.5 x 30mm
144-35135	Solid Locking Screw - 3.5 x 35mm

3.5mm Cannulated Lag Screws

Part #	Description
144-35224	Cannulated Compression Screw 3.5 x 24mm
144-35226	Cannulated Compression Screw 3.5 x 26mm
144-35228	Cannulated Compression Screw 3.5 x 28mm
144-35230	Cannulated Compression Screw 3.5 x 30mm
144-35232	Cannulated Compression Screw 3.5 x 32mm
144-35234	Cannulated Compression Screw 3.5 x 34mm
144-35236	Cannulated Compression Screw 3.5 x 36mm
144-35238	Cannulated Compression Screw 3.5 x 38mm
144-35240	Cannulated Compression Screw 3.5 x 40mm
144-35245	Cannulated Compression Screw 3.5 x 45mm
144-35250	Cannulated Compression Screw 3.5 x 50mm

Instruments

Joint Preparation (Disposable)

Instruments	Description
113-00114	MTP Cone Rasp - 14mm
113-00116	MTP Cone Rasp - 16mm
113-00118	MTP Cone Rasp - 18mm
113-00120	MTP Cone Rasp - 20mm
113-00214	MTP Cup Rasp - 14mm
113-00216	MTP Cup Rasp - 16mm
113-00218	MTP Cup Rasp - 18mm
113-00220	MTP Cup Rasp - 20mm
144-00016	MTP Barrel Reamer
144-00030	Joint Preparation Rasp
144-00032	Fenestrating Drill

Other Disposable Instruments

Instruments	Description
144-00004	Drill Bit for 3.5mm Screw (2.7mm)
144-00303	Drill Bit for 2.8 Screw (2.0 mm)
144-00011	Olive Wire 1.6mm, Threaded
144-00012	Headed Screw Countersink
144-00014	1.4mm Guidewire
144-00025	2.5mm Cannulated Drill
144-50111	Olive Wire 1.6 mm, Smooth
144-61111	Olive Wire 1.6 mm, Smooth, Short
144-00017	2.5mm Solid Drill with Stop
144-00018	Post Drill, 4.2mm

Set Instruments (non-disposable)

Instruments	Description
144-10000	OMNI Foot Plating Tray
127-00006	AO Handle
144-00002	Grasping Forceps
144-00006	Depth Gauge for 2.8 and 3.5 Screws
144-00308	Drill Sleeve for 2.8 Screw
144-00009	Drill Sleeve for 3.5 Screw
144-00010	T10 Driver, Solid
144-00013	Depth Gauge for Cannulated Screw
144-00015	T15 Cannulated Driver
144-00119	Wire Guide
144-00020	Targeting Guide
144-00021	Post/Peg Adjuster
144-00022	2.5mm Drill Sleeve
144-00023	Post/Peg Drill Guide
144-00026	Guidewire Holder
144-00027	Plate Bender
144-00031	Hintermann Compressor Distractor
144-00122	2.5 mm Drill Sleeve, Long
144-00222	2.5 mm Drill Sleeve
144-00307	Compression Drill Guide, 2.8 & 3.5 screws